

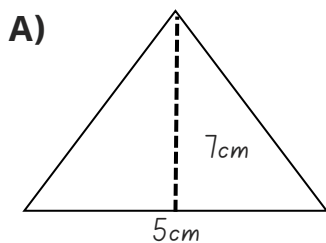

Лице на триъгълник

Изчислете лицата на фигурите долу:



S=

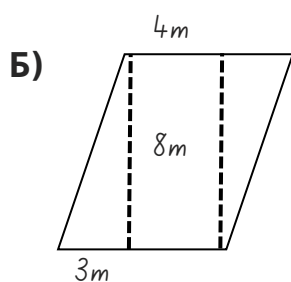

S=

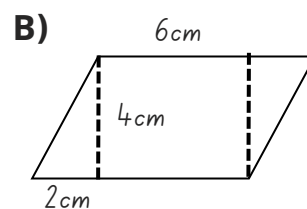

S=

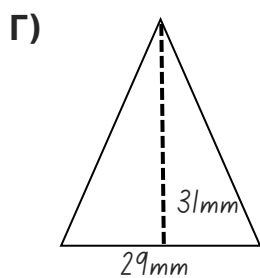

S=

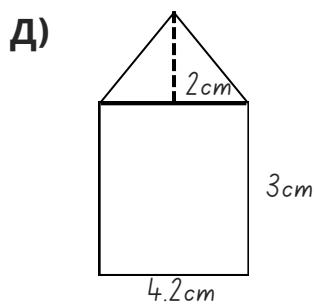

S=

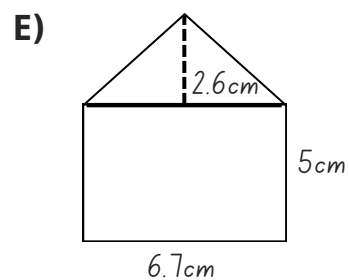

S=



Лице на триъгълник

Изчислете лицата на фигурите долу:

Ж)

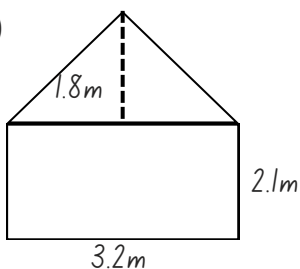

S=

З)

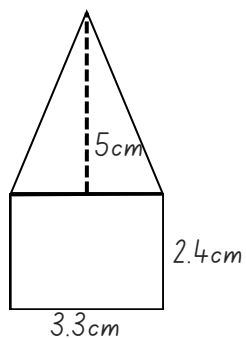

S=

И)

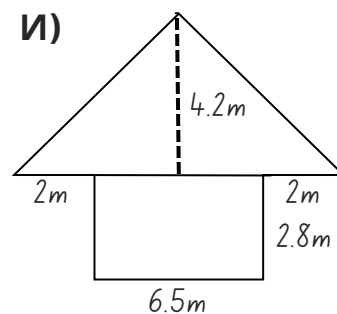

S=

К)

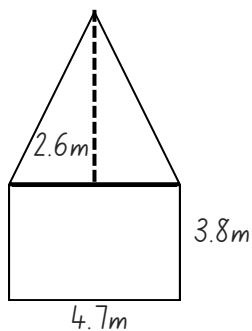

S=

Л)

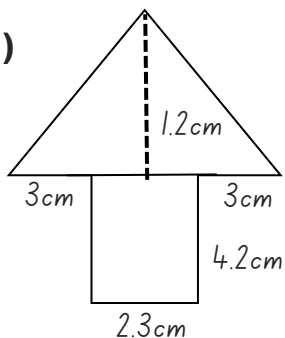

S=

М)

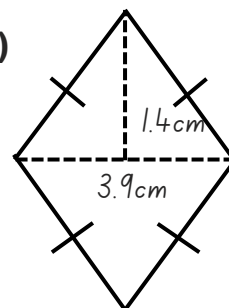

S=